

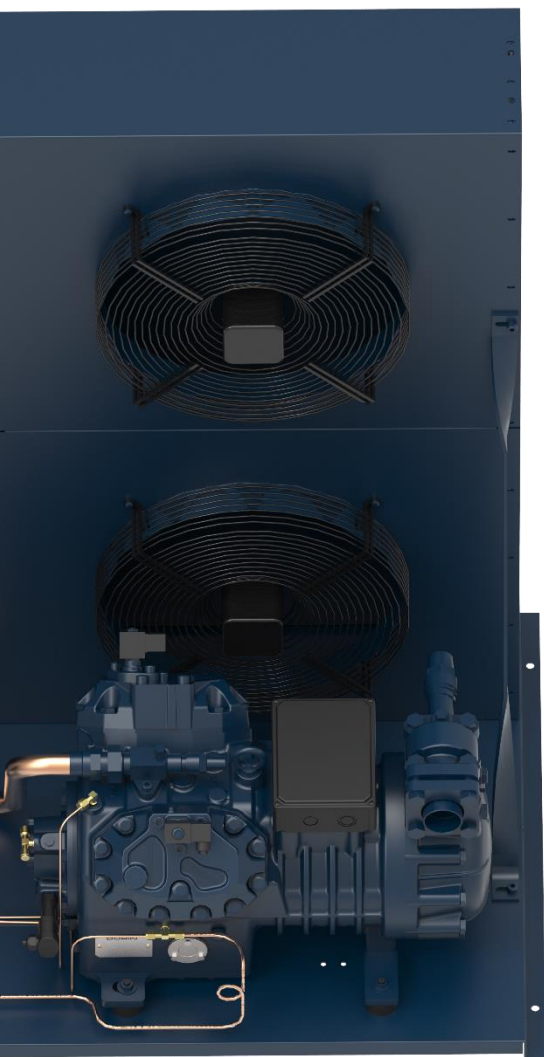

OFFICINE MARIO DORIN SINCE 1918

**DORIN**<sup>®</sup>  
INNOVATION



## E-AU-A2L SERIES

SEMI-HERMETIC AIR COOLED CONDENSING UNIT

HFO/HFC APPLICATION - 50/60 Hz

ECO DESIGN COMPLIANT

FOR A2L REFRIGERANTS





**DORIN Web Software**

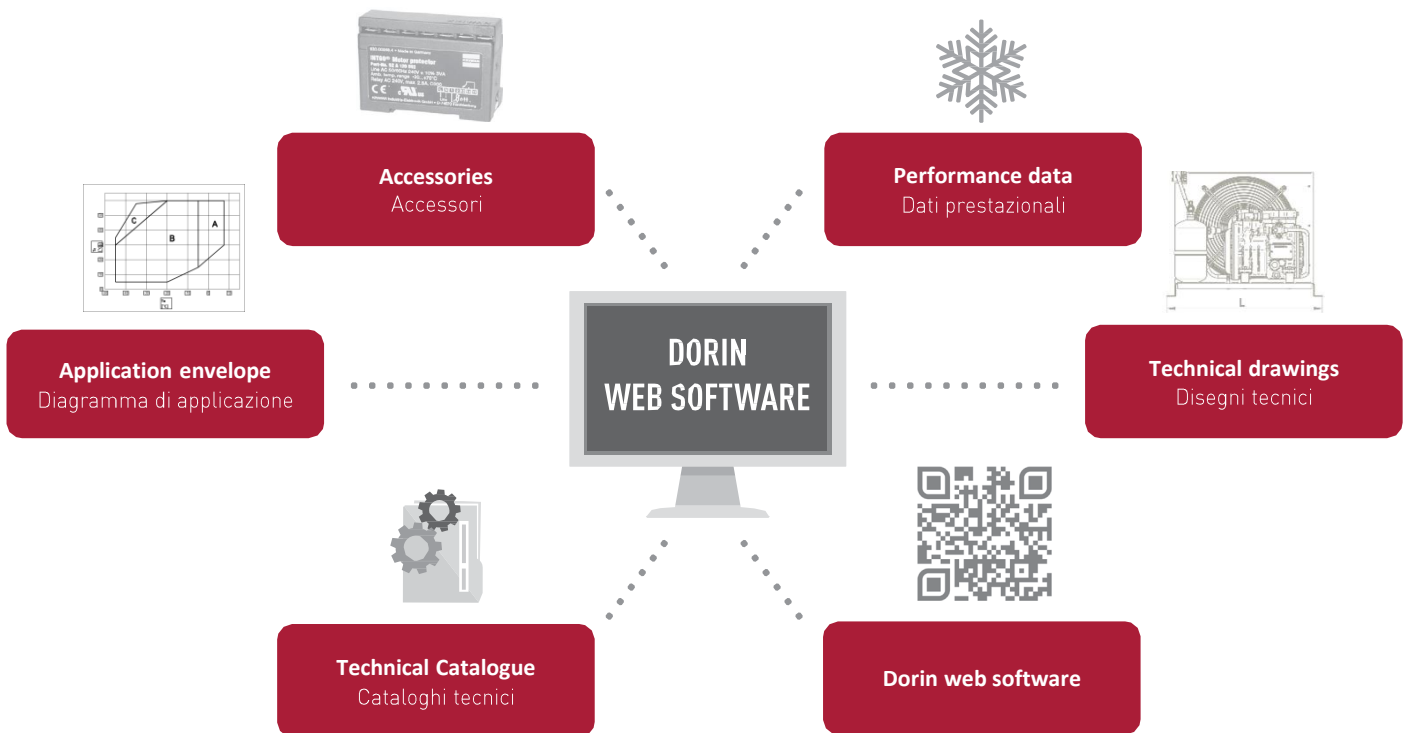

**Factory certifications**

Certificazioni aziendali

**ISO 45001:2018**  
**ISO 9001:2015**

**Condensing units certifications**

Certificazioni di prodotto

**Refrigerants in DORIN software (GWP - AR4)**

Refrigeranti disponibili nel software DORIN (GWP - AR4)

	SAFETY GROUP A2		SAFETY GROUP A1			
LT - MT	R454C (148)	R455A (148)	R448A (1387)		R449A (1397)	
			R407F (1810)		R407A (1825)	R452A (2140)
MT - HT	R454C (148)	R455A (148)	R134A (1430)	R513A (631)	R450A (604)	R407C (1774)

**For all the refrigerants not available in the software please contact DORIN for the calculations**

Per tutti i refrigeranti non disponibili nel software si prega di contattare DORIN per il calcolo prestazionale



## E-AU-A2L SERIES Features

Caratteristiche della gamma E-AU-A2L



### Silent operation in order to comply with all the strictest regulations

Estrema silenziosità per rispettare tutte le più stringenti normative



### Highest levels of efficiency to fulfil the ECODESIGN criteria in the whole application envelope of the unit

Livelli di efficienza ai vertici per rispettare i criteri ECODESIGN nell'intero campo di applicazione dell'unità



### 2 years standard warranty

2 anni di garanzia standard



### All the units are in compliance with the PED directive 2014/68/EU, the design pressure is 30 bar

Tutte le unità sono conformi alla direttiva PED 2014/68/UE, la pressione di progetto PS è di 30 bar.

### All the units are assembled in Italy

Tutte le unità sono assemblate in Italia

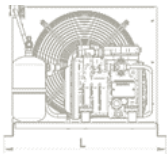

The standard equipment of E-AU units includes an air-cooled condenser with copper pipes and new design aluminium fins, high efficiency electric motor-fans equipped with safety grill, liquid receiver with safety valve and anti-vibration damper on discharge piping (when included), gas and liquid piping, steel frame

La dotazione standard delle nuove unità condensatrici E-AU prevede un condensatore raffreddato ad aria con tubazioni in rame ed alette in alluminio di nuovo disegno, motoventilatori monofase ad alta efficienza con griglia di protezione, ricevitore di liquido con valvola di sicurezza e assorbitore di vibrazioni sulla tubazione di mandata (quando previsto), tubazioni del gas e del liquido, telaio portante



### 230 V / 1 ph / 50-60 Hz fans equipped with internal thermal protection and safety grill

Ventilatori 230 V / 1 ph / 50-60 Hz equipaggiati con protezione termica interna e griglia di protezione

Up to AU-H33 both single and double fans condenser options for almost each compressor model

Fino alla gamma AU-H33 sono disponibili per lo stesso modello di compressore sia il condensatore monoventola, che quello biventola

## E-AU-A2L SERIES Technical Features Features

Caratteristiche tecniche della gamma E-AU-A2L

1

### Caged nuts on the steel frame for an easy installation of aftersale accessories

Dadi in gabbia consentono un facile fissaggio degli accessori su unità già installate

2

### Top brands european accessories

Accessori dei più rinomati marchi europei

3

### Liquid receiver equipped with rotolock valve and safety valve

Ricevitore di liquido equipaggiato con valvola rotolock e valvola di sicurezza

4

### Generously sized copper/aluminum air-cooled condenser with new design fins, optimized heat exchange and low refrigerant charge

Condensatore in rame/alluminio sovradimensionato con nuovo disegno delle alette, scambio termico ottimizzato e bassa carica di refrigerante



## E-AU-A2L range - Displacement

Serie E-AU-A2L – Spostamento volumetrico

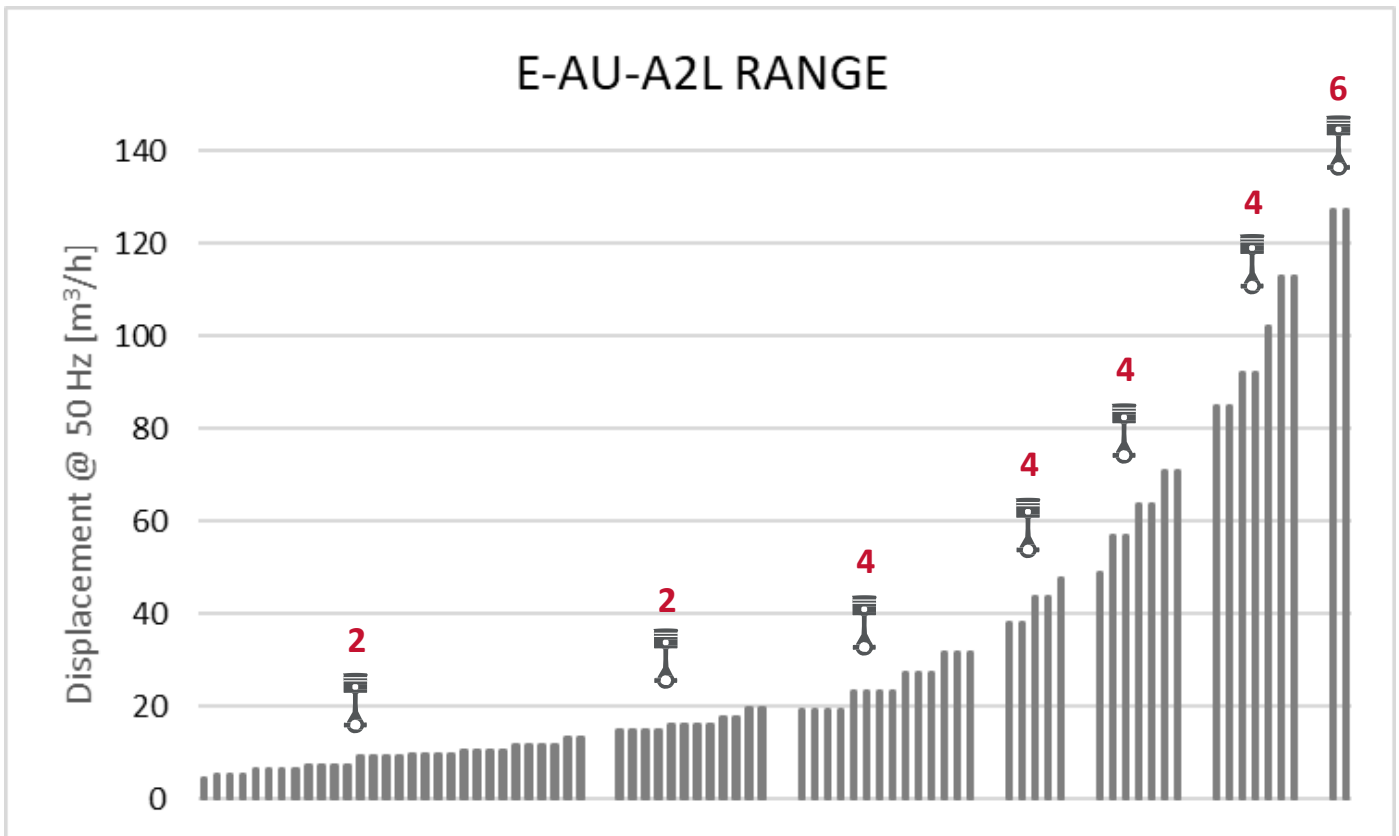

**FROM 4,42 m³/h TO 127,52 m³/h @ 50 Hz  
FROM 0,75 TO 40 HORSE POWER**

## Model name

Nome modello

<b>E-AU-A2L</b>	<b>-2-</b>	<b>H1003CC</b>
RANGE	NUMBER OF FANS	COMPRESSOR MODEL
	-: SINGLE FAN	
	2: DOUBLE FAN	
	4: 4 FANS	

## Application E-AU-A2L SERIES

Applicazioni della gamma E-AU-A2L





**Cold chain storage**  
Celle frigorifere



**Retail**  
Refrigerazione commerciale







**Standard and Optional Accessories for the compressor**

Accessori standard ed optional per il compressore

		MODEL						
● STANDARD   ○ OPTIONAL		H11	H2	H33	H35	H41	H5	H6
	<p><b>Motor Protection (MT) / Protezione motore (MT)</b></p> <p>H11 and H2 series are equipped with a PTC probe on every motor winding set at 140°C. From H33 series and above compressors are equipped with a PTC probe on every motor winding set at 120°C. The sensor requires an external protection module to read the signal from the probe (BT008)</p> <p>Le gamme H11 e H2 hanno la protezione con un sensore PTC su ogni avvolgimento del motore impostato a 140 °C. Dalla serie H33 in su i compressori sono equipaggiati con un sensore PTC su ogni avvolgimento del motore impostato a 120 °C. Il sensore richiede un modulo di protezione esterno per leggere il segnale in uscita dalla PTC (BT008)</p>	●	●	●	●	●	●	●
	<p><b>Electronic Protection Module (REL) / Modulo di protezione elettronico (REL)</b></p> <p>Keeping under constant control winding temperature and discharge temperature (only for H5, H6, H7) (BT007)</p> <p>Modulo per controllare la temperatura degli avvolgimenti e quella di scarico (quest'ultima solo per le gamme H5, H6, H7) (BT007)</p>	●	●	●	●	●	●	●
	<p><b>Crankcase Heater (CH) / Resistenza carter (CH)</b></p> <p>The heater is 100 W up to H41 included and 200 W for H5/H6/H7 series (BT001)</p> <p>Il riscaldatore ha una potenza di 100 W fino alla gamma H41 e 200 W per la gamma H5/H6/H7 (BT001)</p>	○	○	○	○	○	○	○
	<p><b>Self-regulating crankcase heater (TCH) / Resistenza autoregolante (TCH)</b></p> <p>Increasing the energy efficiency and reducing the warm-up time. The thermal regulated crankcase heater reduces the output power once the set temperature is reached. Depending on the working conditions there is up to 30% energy saving compared to the standard heater (BT001)</p> <p>Rispetto alla resistenza standard CH riduce il tempo di riscaldamento e incrementa l'efficienza. La resistenza autoregolante aiuta a ridurre il consumo in potenza una volta che la temperatura di set è raggiunta. Il voltaggio in ingresso può variare da 120 fino a 400 V. A seconda delle condizioni di funzionamento può garantire fino al 30 % di risparmio energetico rispetto alla resistenza standard (BT001)</p>	○	○	○	○	○	○	○
	<p><b>Maximum discharge temperature sensor (TMAX) / Sonda di massima temperatura di scarico (TMAX)</b></p> <p>A thermistor probe is monitoring the discharge temperature to be kept below 130°C (BT007)</p> <p>Un termistore controlla la temperatura allo scarico con un set point a 130 °C (BT007)</p>						●	●

**Standard and Optional Accessories for the compressor**

Accessori standard ed optional per il compressore

		MODEL						
● STANDARD   ○ OPTIONAL		H11	H2	H33	H35	H41	H5	H6
	<p><b>Oil differential pressure switch (ODPS) / Sensore differenziale di pressione olio (ODPS)</b></p> <p>Compressors with oil pump are equipped with an oil differential pressure switch set at 0,85 bar differential. The oil pressure switch must be connected in series to both thermistors module and all other protections foreseen in the system chain alarm (BT007)</p> <p>I compressori equipaggiati con pompa olio utilizzano hanno un differenziale di pressione settato a 0,85 bar. La protezione per la pressione dell'olio deve essere connessa in serie a tutte le altre protezioni del compressore, come i termistori (BT007)</p>						●	●
	<p><b>Optical oil level sensor (ALL) / Sensore ottico livello olio (ALL)</b></p> <p>Compressors with 4 cylinders and without oil pump can be equipped with an optical oil level sensor, which can be installed in a dedicated hole placed in in correspondence to the internal oil pocket. The sensor is based on an infrared LED and a light receiver. Infrared reflection/refraction depends on the oil level in the pocket (BT007)</p> <p>I compressori con 4 cilindri e senza pompa olio possono essere equipaggiati con un sensore ottico di livello dell'olio che è installato in corrispondenza della «sacca» interna del coperchio. Il sensore funziona grazie ad un emettitore LED e un ricevitore. La riflessione/rifrazione del fascio di infrarossi dipende dal livello di olio nella tasca (BT007)</p>			○	○	○		
	<p><b>Oil charge / Carica olio</b></p> <p>All compressors are charged in the factory with POE or mineral oil before the mechanical and electrical running tests</p> <p>Tutti i compressori sono caricati con POE o olio minerale prima dei test meccanici ed elettrici a fine linea di assemblaggio</p>	●	●	●	●	●	●	●
	<p><b>Capacity control head (CR) / Controllo di capacità (CR)</b></p> <p>A mechanical capacity control system can be applied on compressors from 4 cylinders and above (BT002)</p> <p>Il controllo di capacità è disponibile sui compressori da 4, 6 e 8 cilindri (BT002)</p>			○	○	○	○	○
	<p><b>Stepless capacity control (SLCR) / Regolazione di capacità stepless (SLCR)</b></p> <p>10-100% stepless modulation of the capacity is possible by using a special high-frequency pulsating valve in connection with a dedicated mechanical capacity control head system (BT022)</p> <p>E' possibile utilizzare questo accessorio per il controllo di capacità dal 10% al 100% grazie ad un speciale meccanismo ad alta frequenza sul controllo della valvola regolatrice abbinato al sistema di regolazione elettronica dedicato</p>			○	○	○	○	○
	<p><b>Unloaded start (US) / Partenza a vuoto (US)</b></p> <p>With a part-winding start system it is seldom used the unloaded start for by-passing the suction with the discharge, reducing significantly the absorbed inrush current (BT009)</p> <p>Questo accessorio è utilizzato, insieme ai motori PWS, per creare un bypass tra l'aspirazione e lo scarico del compressore e ridurre le correnti assorbite all'avvio della macchina (BT009)</p>			○	○	○	○	○
	<p><b>Suction and discharge service valves / Rubinetti di aspirazione e scarico</b></p>	●	●	●	●	●	●	●



## Optional Accessories for the unit

Accessori optional per l'unità condensante

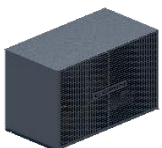
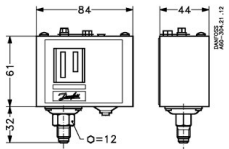
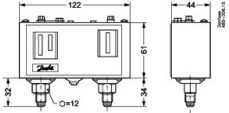

	MODEL						
	EAU-H11	EAU-H2	EAU-H33	EAU-H35	EAU-H41	EAU-H5	EAU-H6
<p>● STANDARD   ○ OPTIONAL</p> <p><b>HP-LP Pressure switch / Pressostato doppio B.P e A.P.</b> High and low pressure switch Pressostato di alta e bassa pressione</p>	○	○	○	○	○	○	○
<p><b>HP Pressure switch / Pressostato A.P.</b> High pressure switch Pressostato di alta pressione</p>	○	○	○	○	○	○	○
<p><b>Filter driers / Filtro disidratatore</b> The function of the dehydrating filter is to protect the system from moisture, acids and solid contaminants La funzione del filtro disidratatore è quella di proteggere il sistema dall'umidità, dagli acidi e dalla contaminazione di solidi</p>	○	○	○	○	○	○	○
<p><b>Moisture-liquid indicator / Indicatore di liquido e umidità</b> The function of liquid and humidity indicators is to verify the actual situation of flow and the presence of moisture in the system La funzione dell'indicatore di liquido e umidità è quella di verificare le condizioni del flusso e la presenza di umidità nel sistema</p>	○	○	○	○	○	○	○
<p><b>Solenoid valve / Valvola solenoide</b> Solenoid valve to close the liquid line after the liquid receiver Valvola solenoide per chiudere la linea del liquido a valle del ricevitore di liquido</p>	○	○	○	○	○	○	○
<p><b>Suction flexible hose / Antivibrante aspirazione</b></p>	○	○	○	○	○	○	○
<p><b>Oil separator / Separatore olio</b> Oil separators ensure that the compressor lubricating oil is fed back directly to the crankcase. This prevents the oil circulating with the refrigerant throughout the circuit, improving the performance of the system Il separatore dell'olio assicura che questo torni indietro al carter del compressore, impedendo che l'olio circoli insieme al refrigerante attraverso il circuito e quindi migliorando le performance del sistema</p>	○	○	○	○	○	○	○
<p><b>Fan speed regulator / Regolatore velocità ventole</b> Fan speed controller stabilizes condensing pressure by changing condenser's fan speed Questo accessorio stabilizza la pressione di condensazione variando la velocità delle ventole del condensatore</p>	○	○	○	○	○	○	○
<p><b>Weather protection housing / Carenatura</b></p>	○	○	○	○	○	○	○

Technical features

Caratteristiche tecniche

SERIE - RANGE	Unità condensatrice Condensing unit	Compressore - Compressor				Ricevitore Receiver	Connessioni - Connections			Peso netto Net weight	
		Modello Model	m³/h [@50 Hz]	m³/h [@60 Hz]	Max corrente di funzionamento Max operating current		Aspirazione Suction SL	Liquido Liquid FL			
								Tensione Voltage	[A] [@50Hz]		Vol. [l]
H11	E-AU-A2L-H80CC	H80CC	4,42	5,30	265 - 290 / 3 / 60 440 - 480 / 3 / 60	4.2 / 2.4	2,3	12s	1"	1/2"	58
	E-AU-A2L-H80CS	H80CS	5,37	6,44		4.2 / 2.4	2,3	16s	1"	1/2"	62
	E-AU-A2L-H101CC	H101CC	5,37	6,44		5.0 / 2.9	2,3	16s	1"	1/2"	63
	E-AU2-A2L-H101CC	H101CC	5,37	6,44		5.0 / 2.9	2,3	16s	1"	1/2"	69
	E-AU-A2L-H101CS	H101CS	6,71	8,05		5.0 / 2.9	2,3	16s	1"	1/2"	63
	E-AU2-A2L-H101CS	H101CS	6,71	8,05		5.0 / 2.9	2,3	16s	1"	1/2"	69
	E-AU-A2L-H151CC	H151CC	6,71	8,05		5.9 / 3.4	2,3	16s	1"	1/2"	64
	E-AU2-A2L-H151CC	H151CC	6,71	8,05		5.9 / 3.4	2,3	16s	1"	1/2"	71
	E-AU-A2L-H151CS	H151CS	7,50	9,00		5.9 / 3.4	2,3	16s	1"	1/2"	65
	E-AU2-A2L-H151CS	H151CS	7,50	9,00		5.9 / 3.4	2,3	16s	1"	1/2"	71
	E-AU-A2L-H181CC	H181CC	7,50	9,00		7.6 / 4.4	2,3	16s	1"	1/2"	68
	E-AU2-A2L-H181CC	H181CC	7,50	9,00		7.6 / 4.4	2,3	16s	1"	1/2"	73
	E-AU-A2L-H181CS	H181CS	9,16	10,99		7.6 / 4.4	2,3	16s	1"	1/2"	68
	E-AU2-A2L-H181CS	H181CS	9,16	10,99		7.6 / 4.4	2,3	16s	1"	1/2"	73
	E-AU-A2L-H201CC	H201CC	9,16	10,99		10.4 / 6.0	2,3	16s	1"	1/2"	69
	E-AU2-A2L-H201CC	H201CC	9,16	10,99		10.4 / 6.0	2,3	16s	1"	1/2"	74
	E-AU-A2L-H201CS	H201CS	9,88	11,86		7.6 / 4.4	2,3	18s	1"	1/2"	69
	E-AU2-A2L-H201CS	H201CS	9,88	11,86		7.6 / 4.4	2,3	18s	1"	1/2"	74
	E-AU-A2L-H221CC	H221CC	9,88	11,86		10.4 / 6.0	2,3	18s	1"	1/2"	70
	E-AU2-A2L-H221CC	H221CC	9,88	11,86		10.4 / 6.0	2,3	18s	1"	1/2"	75
	E-AU-A2L-H221CS	H221CS	10,61	12,73		10.4 / 6.0	2,3	18s	1"	1/2"	70
	E-AU2-A2L-H221CS	H221CS	10,61	12,73		10.4 / 6.0	3,9	18s	1"	1/2"	93
	E-AU-A2L-H251CC	H251CC	10,61	12,73		12.6 / 7.3	3,9	18s	1"	1/2"	88
	E-AU2-A2L-H251CC	H251CC	10,61	12,73		12.6 / 7.3	3,9	18s	1"	1/2"	93
	E-AU-A2L-H251CS	H251CS	11,64	13,97		10.4 / 6.0	2,3	18s	1"	1/2"	70
	E-AU2-A2L-H251CS	H251CS	11,64	13,97		10.4 / 6.0	3,9	18s	1"	1/2"	93
	E-AU-A2L-H281CC	H281CC	11,64	13,97		12.6 / 7.3	3,9	18s	1"	1/2"	88
	E-AU2-A2L-H281CC	H281CC	11,64	13,97		12.6 / 7.3	3,9	18s	1"	1/2"	93
E-AU-A2L-H281CS	H281CS	13,23	15,88	12.6 / 7.3	3,9	18s	1"	1/2"	100		
E-AU2-A2L-H281CS	H281CS	13,23	15,88	12.6 / 7.3	3,9	18s	1"	1/2"	95		
H2	E-AU-A2L-H290CS	H290CS	14,74	17,69	220 - 240 / 3 / 50 380 - 420 / 3 / 50	12.9 / 7.5	3,9	22s	1"	1/2"	100
	E-AU2-A2L-H290CS	H290CS	14,74	17,69		12.9 / 7.5	3,9	22s	1"	1/2"	107
	E-AU-A2L-H300CC	H300CC	14,74	17,69		16.2 / 9.4	5,7	22s	1"	5/8"	110
	E-AU2-A2L-H300CC	H300CC	14,74	17,69		16.2 / 9.4	5,7	22s	1"	5/8"	115
	E-AU-A2L-H300CS	H300CS	15,94	19,13		12.9 / 7.5	3,9	28s	1"	1/2"	100
	E-AU2-A2L-H300CS	H300CS	15,94	19,13		12.9 / 7.5	3,9	28s	1"	1/2"	108
	E-AU-A2L-H350CC	H350CC	15,94	19,13		16.2 / 9.4	5,7	28s	1"	5/8"	110
	E-AU2-A2L-H350CC	H350CC	15,94	19,13		16.2 / 9.4	5,7	28s	1"	5/8"	115
	E-AU-A2L-H380CC	H380CC	17,53	21,04		12.9 / 7.5	5,7	28s	1"	1/2"	111
	E-AU2-A2L-H380CC	H380CC	17,53	21,04		12.9 / 7.5	5,7	28s	1"	1/2"	116
	E-AU-A2L-H390CS	H390CS	19,53	23,44		16.2 / 9.4	3,9	28s	1"	5/8"	108
	E-AU2-A2L-H390CS	H390CS	19,53	23,44		16.2 / 9.4	3,9	28s	1"	5/8"	110
H33	E-AU-A2L-H355CS	H355CS	19,29	23,14	380 - 420 / 3 / 50 PWS	18.1 / 10.5	3,9	22s	1"	1/2"	129
	E-AU2-A2L-H355CS	H355CS	19,29	23,14		18.1 / 10.5	5,7	22s	1"	5/8"	143
	E-AU-A2L-H405CC	H405CC	19,29	23,14		25.0 / 14.5	5,7	22s	1"	5/8"	130
	E-AU2-A2L-H405CC	H405CC	19,29	23,14		25.0 / 14.5	5,7	22s	1"	5/8"	154
	E-AU-A2L-H405CS	H405CS	23,13	27,76		18.1 / 10.5	3,9	28s	1"	1/2"	130
	E-AU2-A2L-H405CS	H405CS	23,13	27,76		18.1 / 10.5	5,7	28s	1"	5/8"	144
	E-AU-A2L-H505CC	H505CC	23,13	27,76		25.0 / 14.5	5,7	28s	1"	5/8"	131
	E-AU2-A2L-H505CC	H505CC	23,13	27,76		25.0 / 14.5	5,7	28s	1"	5/8"	155
	E-AU-A2L-H505CS	H505CS	27,33	32,80		25.0 / 14.5	5,7	28s	1"	5/8"	131
	E-AU2-A2L-H505CS	H505CS	27,33	32,80		25.0 / 14.5	7,6	28s	1"	3/4"	155
	E-AU-A2L-H705CC	H705CC	27,33	32,80		34.0 / 19.5	7,6	28s	1"	3/4"	155
	E-AU2-A2L-H705CC	H705CS	31,88	38,26		25.0 / 14.5	5,7	28s	1"	5/8"	131
	E-AU-A2L-H705CS	H705CS	31,88	38,26		25.0 / 14.5	7,6	28 s.	1"	5/8"	155
	E-AU2-A2L-H705CS	H755CC	31,88	38,26		34.0 / 19.5	7,6	28s	1"	3/4"	184
H35	E-AU-A2L-H751CS	H751CS	38,06	45,67	380 - 420 / 3 / 50 PWS	34.0 / 19.5	7,6	35s	1"	3/4"	171
	E-AU2-A2L-H1002CC	H1002CC	38,06	45,67		40.0 / 23.0	7,6	35s	1"	3/4"	196
	E-AU-A2L-H801CS	H801CS	43,73	52,48		34.0 / 19.5	15	35s	1-1/4"	7/8"	159
	E-AU2-A2L-H1003CC	H1003CC	43,73	52,48		40.0 / 23.0	15	35s	1-1/4"	7/8"	211
	E-AU-A2L-H901CS	H901CS	47,80	57,36		40.0 / 23.0	15	35s	1-1/4"	7/8"	192
H41	E-AU2-A2L-H1501CC	H1501CC	48,82	58,58	380 - 420 / 3 / 50 PWS	34	15	42s	1-1/4"	7/8"	253
	E-AU-A2L-H1501CS	H1501CS	56,87	68,25		28	15	35s	1-1/4"	7/8"	223
	E-AU2-A2L-H2001CC	H2001CC	56,87	68,25		38	15	42s	1-1/4"	7/8"	257
	E-AU-A2L-H1601CS	H1601CS	63,76	76,51		34	15	42s	1-1/4"	7/8"	256
	E-AU2-A2L-H2201CC	H2201CC	63,76	76,51		45	15	42s	1-1/4"	7/8"	287
	E-AU-A2L-H2201CS	H2201CS	70,84	85,01		38	15	42s	1-1/4"	7/8"	251
H5	E-AU4-A2L-H2401CC	H2401CC	70,84	85,01	380 - 420 / 3 / 50 PWS	45	15	54s	1-1/4"	7/8"	339
	E-AU4-A2L-H2500CS	H2500CS	85,01	102,01		45	15	54s	1-1/4"	7/8"	355
	E-AU4-A2L-H3000CC	H3000CC	85,01	102,01		56	19	54s	1-1/4"	7/8"	357
	E-AU4-A2L-H2700CS	H2700CS	92,25	110,70		48	19	54s	1-1/4"	7/8"	357
	E-AU4-A2L-H3200CC	H3200CC	92,25	110,70		60	19	54s	1-1/4"	7/8"	357
	E-AU4-A2L-H2900CS	H2900CS	102,35	122,82		56	19	54s	1-1/4"	7/8"	357
	E-AU4-A2L-H3001CS	H3001CS	112,97	135,57		60	24,5	54s	1-1/4"	7/8"	432
H6	E-AU4-A2L-H3501CC	H3501CC	112,97	135,57	380 - 420 / 3 / 50 PWS	66	24,5	54s	1-1/4"	7/8"	432
	E-AU4-A2L-H3500CS	H3500CS	127,52	153,02		60	24,5	54s	1-1/4"	7/8"	460
	E-AU4-A2L-H4000CC	H4000CC	127,52	153,02		75	24,5	54s	1-1/4"	7/8"	476

\* Other voltages and electrical supplies upon request. The air flows are real and take into account the losses incurred by the fins.

\* Altri tipi di corrente e tensione su richiesta. Le portate di aria sono reali e tengono conto delle perdite sul pacco alettato.

## Technical features

Caratteristiche tecniche

SERIE - RANGE	Unità condensatrice Condensing unit	Ventilatori - Fans								
		Portata Aria Air flow		Potenza assorbita Ventilatori (tot.) Fans Power absorption (tot.)		Corrente assorbita (tot.) Current consumption (tot.)		Capacità condensatore Condenser capacity		n° x Ø
		[m³/h] [@50Hz]	[m³/h] [@60Hz]	[W] [@50Hz]	[W] [@60Hz]	[A] [@50Hz]	[A] [@60Hz]	n° x µF [@50Hz]	n° x µF [@60Hz]	
H11	E-AU-A2L-H80CC	2150	2420	165	240	0,75	0,99	1x6	1x6	1x350
	E-AU-A2L-H80CS	2150	2420	165	240	0,75	0,99	1x6	1x6	1x350
	E-AU-A2L-H101CC	2150	2420	165	240	0,75	0,99	1x6	1x6	1x350
	E-AU2-A2L-H101CC	2600	2930	170	200	0,84	0,92	2x3	2x3	2x300
	E-AU-A2L-H101CS	2150	2420	165	240	0,75	0,99	1x6	1x6	1x350
	E-AU2-A2L-H101CS	2600	2930	170	200	0,84	0,92	2x3	2x3	2x300
	E-AU-A2L-H151CC	2000	2250	165	240	0,75	0,99	1x6	1x6	1x350
	E-AU2-A2L-H151CC	2600	2930	170	200	0,84	0,92	2x3	2x3	2x300
	E-AU-A2L-H151CS	2000	2250	165	240	0,75	0,99	1x6	1x6	1x350
	E-AU2-A2L-H151CS	2600	2930	170	200	0,84	0,92	2x3	2x3	2x300
	E-AU-A2L-H181CC	2000	2250	165	240	0,75	0,99	1x6	1x6	1x350
	E-AU2-A2L-H181CC	2350	2650	170	200	0,84	0,92	2x3	2x3	2x300
	E-AU-A2L-H181CS	2000	2250	165	240	0,75	0,99	1x6	1x6	1x350
	E-AU2-A2L-H181CS	2350	2650	170	200	0,84	0,92	2x3	2x3	2x300
	E-AU-A2L-H201CC	2000	2250	165	240	0,75	0,99	1x6	1x6	1x350
	E-AU2-A2L-H201CC	2350	2650	170	200	0,84	0,92	2x3	2x3	2x300
	E-AU-A2L-H201CS	1300	150	74	78	0,35	0,37	1x3	1x3	1x350
	E-AU2-A2L-H201CS	2350	2650	170	200	0,84	0,92	2x3	2x3	2x300
	E-AU-A2L-H221CC	2000	2250	165	240	0,75	0,99	1x6	1x6	1x350
	E-AU2-A2L-H221CC	2350	2650	170	200	0,84	0,92	2x3	2x3	2x300
	E-AU-A2L-H221CS	1300	1450	74	78	0,35	0,37	1x3	1x3	1x350
	E-AU2-A2L-H221CS	3200	3730	148	156	0,7	0,74	1x3	1x3	2x350
	E-AU-A2L-H251CC	5500	6190	225	330	1,05	1,5	1x8	1x8	1x450
	E-AU2-A2L-H251CC	4900	5520	330	480	1,5	1,98	2x6	2x6	2x350
	E-AU-A2L-H251CS	1300	1450	74	78	0,35	0,37	1x3	1x3	1x350
	E-AU2-A2L-H251CS	3200	3730	148	156	0,7	0,74	2x6	2x6	2x350
	E-AU-A2L-H281CC	5500	6190	225	330	1,05	1,5	1x8	1x8	1x450
	E-AU2-A2L-H281CC	4900	5520	330	480	1,5	1,98	2x6	2x6	2x350
E-AU-A2L-H281CS	3700	4210	110	150	0,5	0,66	1x4	1x4	1x450	
E-AU2-A2L-H281CS	3200	3730	148	156	0,7	0,74	2x6	2x6	2x350	
E-AU-A2L-H290CS	3700	4210	110	150	0,5	0,66	1x4	1x4	1x450	
E-AU2-A2L-H290CS	3200	3730	148	156	0,7	0,74	2x6	2x6	2x350	
H2	E-AU-A2L-H300CC	5700	6420	225	330	1,05	1,5	1x8	1x8	1x450
	E-AU2-A2L-H300CC	5100	5740	330	480	1,5	1,98	2x6	2x6	2x350
	E-AU-A2L-H300CS	3700	4210	110	150	0,5	0,66	1x4	1x4	1x450
	E-AU2-A2L-H300CS	3200	3730	148	156	0,7	0,74	2x6	2x6	2x350
	E-AU-A2L-H350CC	5700	6420	225	330	1,05	1,5	1x8	1x8	1x450
	E-AU2-A2L-H351CC	5100	5740	330	480	1,5	1,98	2x6	2x6	2x350
	E-AU-A2L-H380CC	5700	6420	225	330	1,05	1,5	1x8	1x8	1x450
	E-AU2-A2L-H381CC	5100	5740	330	480	1,5	1,98	2x6	2x6	2x350
	E-AU-A2L-H390CS	3700	4210	110	150	0,5	0,66	1x4	1x4	1x450
	E-AU2-A2L-H390CS	3200	3730	148	156	0,7	0,74	2x6	2x6	2x350
	E-AU-A2L-H355CS	3700	4210	110	150	0,5	0,66	1x4	1x4	1x450
	E-AU2-A2L-H355CS	3400	3930	148	156	0,7	0,74	2x6	2x6	2x350
	E-AU-A2L-H405CC	5700	6420	225	330	1,05	1,5	1x8	1x8	1x450
	E-AU2-A2L-H405CC	9600	10800	450	660	2,1	3	2x8	2x8	2x450
	E-AU-A2L-H405CS	3700	4210	110	150	0,5	0,66	1x4	1x4	1x450
	E-AU2-A2L-H405CS	3400	3930	148	156	0,7	0,74	2x6	2x6	2x350
H33	E-AU-A2L-H505CC	5700	6420	225	330	1,05	1,5	1x8	1x8	1x450
	E-AU2-A2L-H505CC	9600	10800	450	660	2,1	3	2x8	2x8	2x450
	E-AU-A2L-H505CS	3850	4310	110	150	0,5	0,66	1x4	1x4	1x450
	E-AU2-A2L-H505CS	6500	7300	225	330	1,05	1,5	1x8	1x8	1x450
	E-AU2-A2L-H705CC	9600	10800	450	660	2,1	3	2x8	2x8	2x450
	E-AU-A2L-H705CS	3850	4330	110	150	0,5	0,66	1x4	1x4	1x450
	E-AU2-A2L-H705CS	6500	7300	220	300	1	1,32	2x4	2x4	2x450
	E-AU2-A2L-H755CC	11500	12940	450	660	2,1	3	2x8	2x8	2x450
	E-AU2-A2L-H751CS	6500	7220	220	300	1	1,32	2x4	2x4	2x450
	E-AU2-A2L-H1002CC	11500	12940	450	660	2,1	3	2x8	2x8	2x450
H35	E-AU2-A2L-H801CS	7700	9600	220	300	1	1,32	2x4	2x4	2x450
	E-AU2-A2L-H1003CC	14500	16320	1400	2120	6,6	9,4	2x16	2x16	2x500
	E-AU2-A2L-H901CS	7700	9600	220	300	1	1,32	2x4	2x4	2x450
	E-AU2-A2L-H1501CC	14500	16320	1400	2120	6,6	9,4	2x16	2x16	2x500
	E-AU2-A2L-H1501CS	7700	9600	220	300	1	1,32	2x4	2x4	2x450
	E-AU2-A2L-H2001CC	14500	16320	1400	2120	6,6	9,4	2x16	2x16	2x500
H41	E-AU2-A2L-H1601CS	9500	10720	460	620	2,1	2,92	2x10	2x10	2x500
	E-AU4-A2L-H2201CC	23000	25880	900	1320	4,2	6	4x8	4x8	4x450
	E-AU2-A2L-H2201CS	9500	10720	460	620	2,1	2,92	2x10	2x10	2x500
	E-AU4-A2L-H2401CC	23000	25880	900	1320	4,2	6	4x8	4x8	4x450
	E-AU4-A2L-H2500CS	15000	16780	440	600	4	2,64	4x4	4x4	4x450
	E-AU4-A2L-H3000CC	21000	23630	900	1320	4,2	6	4x8	4x8	4x450
H5	E-AU4-A2L-H2700CS	14400	16380	440	600	4	2,64	4x4	4x4	4x450
	E-AU4-A2L-H3200CC	21000	23630	900	1320	4,2	6	4x8	4x8	4x450
	E-AU4-A2L-H2900CS	14400	16380	440	600	4	2,64	4x4	4x4	4x450
	E-AU4-A2L-H3001CS	19000	21570	920	1240	4,2	6,4	4x10	4x10	4x500
	E-AU4-A2L-H3501CC	29000	32630	2800	4240	13,2	18,8	4x16	4x16	4x500
	E-AU4-A2L-H3500CS	19000	21570	880	1160	3,88	5,2	4x5	4x5	4x500
H6	E-AU4-A2L-H4000CC	29000	32630	2800	4240	13,2	18,8	4x16	4x16	4x500

\* Other voltages and electrical supplies upon request. The air flows are real and take into account the losses incurred by the fins.

\* Altri tipi di corrente e tensione su richiesta. Le portate di aria sono reali e tengono conto delle perdite sul pacco alettato.

Technical Drawings

Disegni tecnici

E-AU-A2L

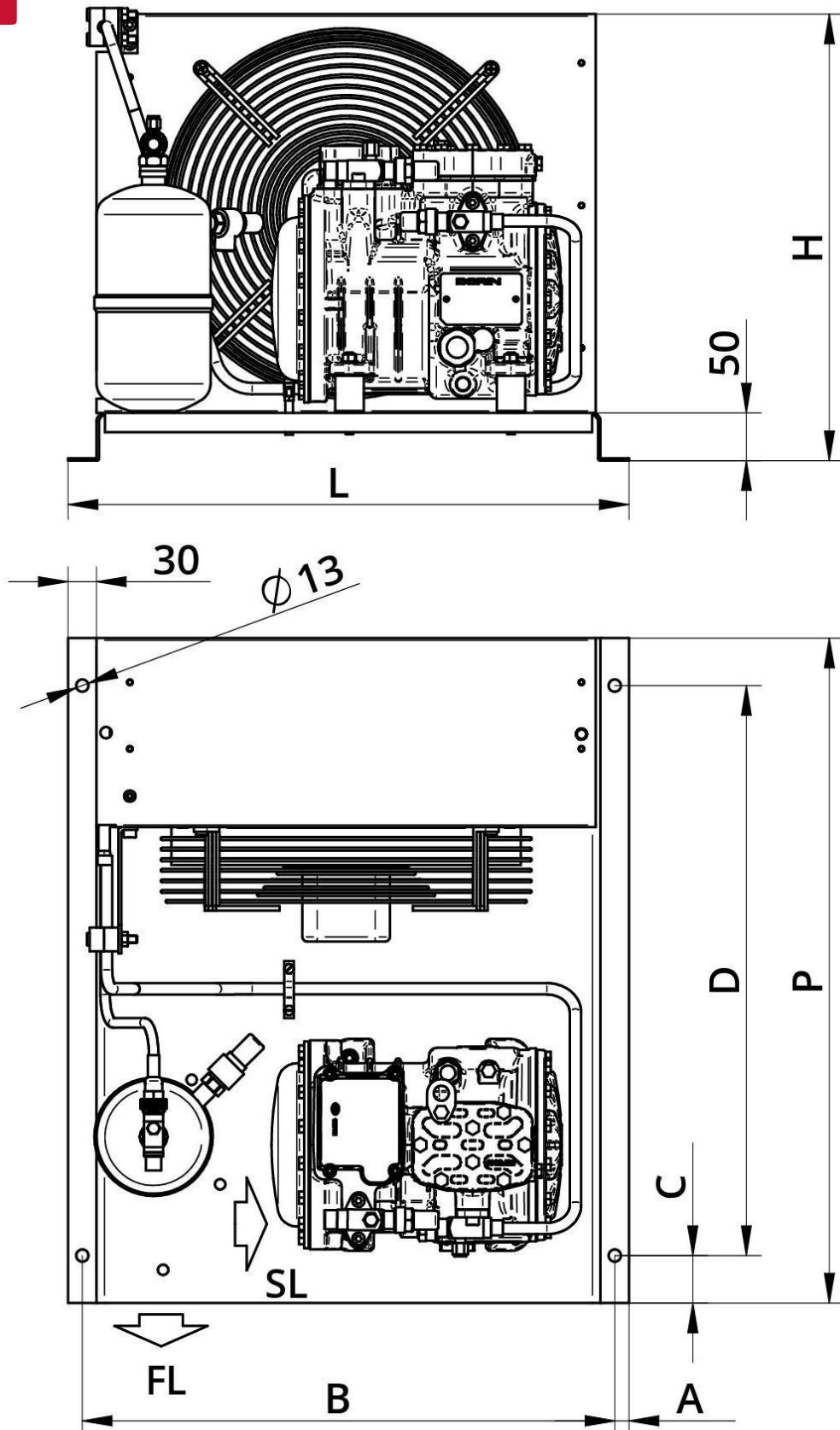

Technical Drawings

Disegni tecnici

E-AU2-A2L

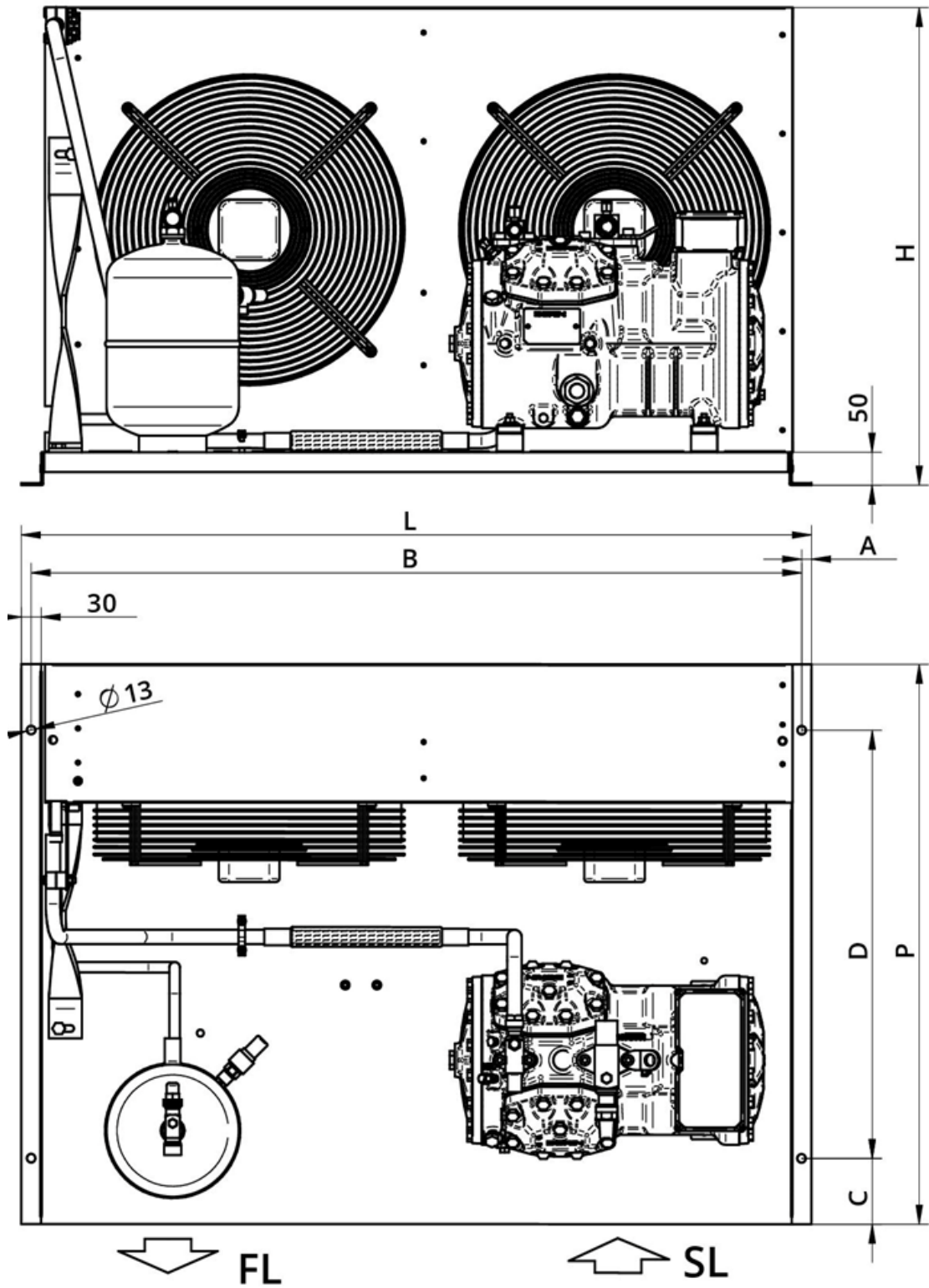

Technical Drawings

Disegni tecnici

E-AU4-A2L

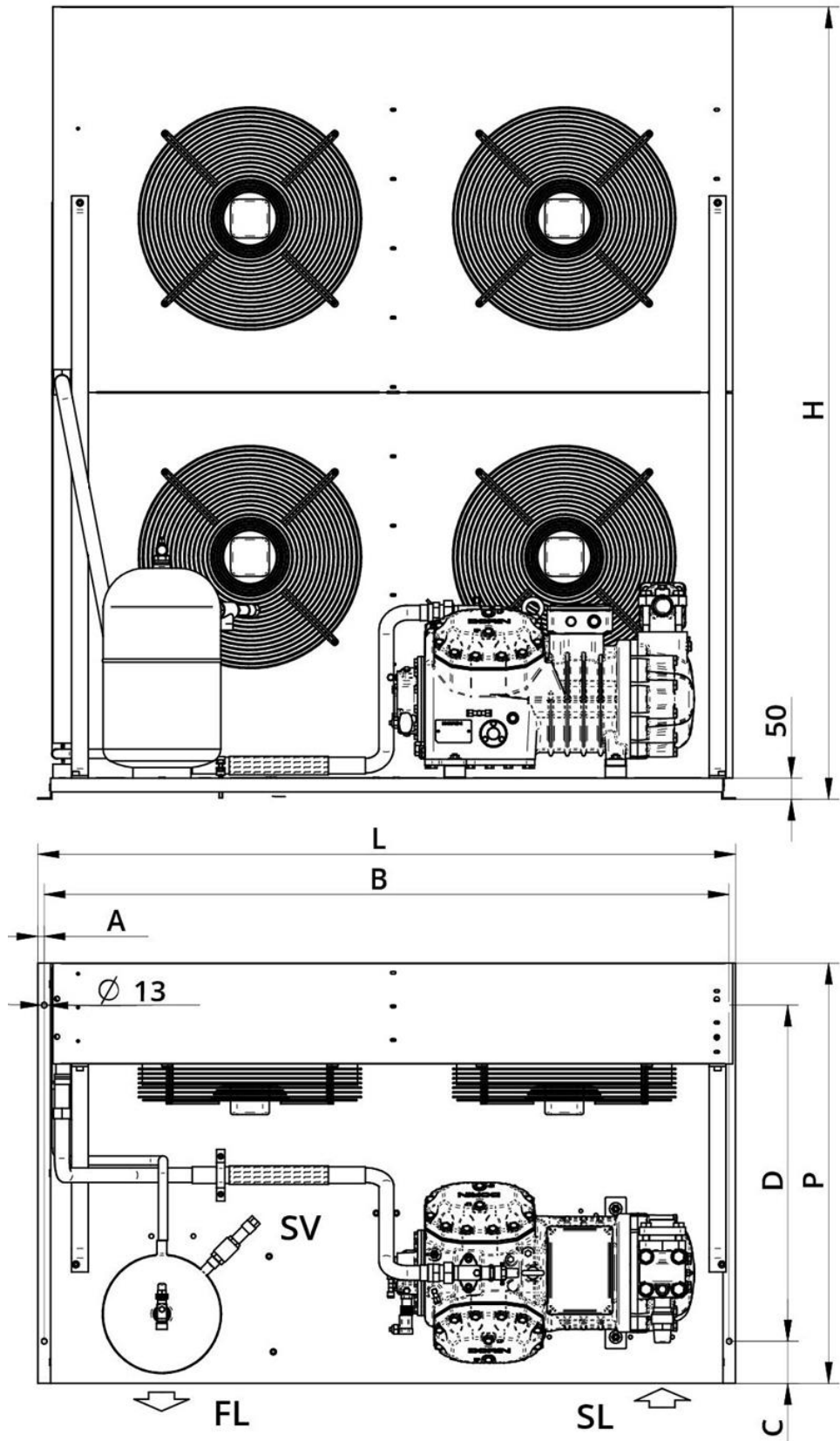

## Overall dimensions

Ingombri

RANGE GAMMA	MODEL MODELLO	OVERALL DIMENSIONS DIMENSIONE GRUPPI						
		L	P	H	A	B	C	D
		[mm]	[mm]	[mm]	[mm]	[mm]	[mm]	[mm]
<b>H11</b>	E-AU-A2L-H80CC	590	700	470	15	560	50	600
	E-AU-A2L-H80CS	590	700	470	15	560	50	600
	E-AU-A2L-H101CC	590	700	470	15	560	50	600
	E-AU2-A2L-H101CC	950	700	425	15	920	50	600
	E-AU-A2L-H101CS	590	700	470	15	560	50	600
	E-AU2-A2L-H101CS	950	700	425	15	920	50	600
	E-AU-A2L-H151CC	590	700	470	15	560	50	600
	E-AU2-A2L-H151CC	950	700	425	15	920	50	600
	E-AU-A2L-H151CS	590	700	470	15	560	50	600
	E-AU2-A2L-H151CS	950	700	425	15	920	50	600
	E-AU-A2L-H181CC	590	700	520	15	560	50	600
	E-AU2-A2L-H181CC	950	700	425	15	920	50	600
	E-AU-A2L-H181CS	590	700	520	15	560	50	600
	E-AU2-A2L-H181CS	950	700	425	15	920	50	600
	E-AU-A2L-H201CC	590	700	520	15	560	50	600
	E-AU2-A2L-H201CC	950	700	425	15	920	50	600
	E-AU-A2L-H201CS	590	700	520	15	560	50	600
	E-AU2-A2L-H201CS	950	700	425	15	920	50	600
	E-AU-A2L-H221CC	590	700	520	15	560	50	600
	E-AU2-A2L-H221CC	950	700	425	15	920	50	600
	E-AU-A2L-H221CS	590	700	520	15	560	50	600
	E-AU2-A2L-H221CS	1200	700	525	15	1170	50	600
	E-AU-A2L-H251CC	950	700	675	15	920	50	600
	E-AU2-A2L-H251CC	1200	700	525	15	1170	50	600
	E-AU-A2L-H251CS	590	700	520	15	560	50	600
	E-AU2-A2L-H251CS	1200	700	525	15	1170	50	600
	E-AU-A2L-H281CC	950	700	675	15	920	50	600
	E-AU2-A2L-H281CC	1200	700	525	15	1170	50	600
E-AU-A2L-H281SB	950	700	675	15	920	50	600	
E-AU2-A2L-H281SB	1200	700	525	15	1170	50	600	
<b>H2</b>	E-AU-A2L-H290CS	950	700	675	15	920	50	600
	E-AU2-A2L-H290CS	1200	700	525	15	1170	50	600
	E-AU-A2L-H300CC	950	700	825	15	920	50	600
	E-AU2-A2L-H300CC	1200	700	675	15	1170	50	600
	E-AU-A2L-H300CS	950	700	675	15	920	50	600
	E-AU2-A2L-H300CS	1200	700	525	15	1170	50	600
	E-AU-A2L-H350CC	950	700	825	15	920	50	600
	E-AU2-A2L-H351CC	1200	700	675	15	1170	50	600
	E-AU-A2L-H350SB	950	700	825	15	920	50	600
	E-AU2-A2L-H350SB	1200	700	675	15	1170	50	600
	E-AU-A2L-H380CC	950	700	675	15	920	50	600
	E-AU2-A2L-H381CC	1200	700	525	15	1170	50	600

## Overall dimensions

Ingombri

RANGE GAMMA	MODEL MODELLO	OVERALL DIMENSIONS DIMENSIONE GRUPPI						
		L	P	H	A	B	C	D
		[mm]	[mm]	[mm]	[mm]	[mm]	[mm]	[mm]
<b>H33</b>	E-AU-A2L-H355CS	950	850	675	15	920	50	650
	E-AU2-A2L-H355CS	1200	850	675	15	1170	50	650
	E-AU-A2L-H405CC	950	850	825	15	926	50	650
	E-AU2-A2L-H405CC	1200	850	725	15	1170	50	650
	E-AU-A2L-H405CS	950	850	675	15	920	50	650
	E-AU2-A2L-H405CS	1200	850	675	15	1170	50	650
	E-AU-A2L-H505CC	950	850	825	15	920	50	650
	E-AU2-A2L-H505CC	1200	850	725	15	1170	50	650
	E-AU-A2L-H505CS	950	850	825	15	920	50	650
	E-AU2-A2L-H505CS	1200	850	725	15	1170	50	650
	E-AU2-A2L-H705CC	1200	850	725	15	1170	50	650
	E-AU-A2L-H705CS	950	850	825	15	920	50	650
	E-AU2-A2L-H705CS	1200	850	725	15	1170	50	650
E-AU2-A2L-H755CC	1660	850	825	15	1630	50	650	
<b>H35</b>	E-AU2-A2L-H751CS	1200	850	725	15	1170	50	650
	E-AU2-A2L-H1002CC	1660	850	825	15	1630	50	650
	E-AU2-A2L-H851CS	1660	850	825	15	1630	50	650
	E-AU2-A2L-H1201CC	1660	850	825	15	1630	50	650
	E-AU2-A2L-H1001CS	1660	850	825	15	1630	50	650
<b>H41</b>	E-AU2-A2L-H1501CC	1660	850	980	15	1630	50	650
	E-AU2-A2L-H1501CS	1660	850	825	15	1630	50	650
	E-AU2-A2L-H2001CC	1660	850	980	15	1630	50	650
	E-AU2-A2L-H1601CS	1660	850	980	15	1630	50	650
	E-AU4-A2L-H2201CC	1660	850	1480	15	1630	50	650
	E-AU2-A2L-H2000CS	1660	850	1480	15	1630	50	650
	E-AU4-A2L-H2500CC	1660	850	1480	15	1630	50	650
<b>H5</b>	E-AU4-A2L-H2500CS	1660	850	1480	15	1630	50	650
	E-AU4-A2L-H3000CC	1660	850	1480	15	1630	50	650
	E-AU4-A2L-H2700CS	1660	850	1480	15	1630	50	650
	E-AU4-A2L-H3200CC	1660	850	1480	15	1630	50	650
	E-AU4-A2L-H2900CS	1660	850	1480	15	1630	50	650
	E-AU4-A2L-H3000CS	1660	1000	1890	15	1630	50	800
	E-AU4-A2L-H3500CC	1660	1000	1890	15	1630	50	800
<b>H6</b>	E-AU4-A2L-H3500CS	1660	1000	1890	15	1630	50	800
	E-AU4-A2L-H4000CC	1660	1000	1890	15	1630	50	800



## Overall dimensions

Ingombri

RANGE GAMMA	HOUSING UNITS OVERALL DIMENSIONS DIMENSIONE GRUPPI CARENATI								
	MODEL MODELLO	L	P	H	A	B	C	D	
		[mm]	[mm]	[mm]	[mm]	[mm]	[mm]	[mm]	
<b>H11</b>	E-AU-A2L-H80CC	590	710	505	15	560	50	600	
	E-AU-A2L-H80CS	590	710	505	15	560	50	600	
	E-AU-A2L-H101CC	590	710	505	15	560	50	600	
	E-AU2-A2L-H101CC	950	710	460	15	920	50	600	
	E-AU-A2L-H101CS	590	710	505	15	560	50	600	
	E-AU2-A2L-H101CS	950	710	460	15	920	50	600	
	E-AU-A2L-H151CC	590	710	505	15	560	50	600	
	E-AU2-A2L-H151CC	950	710	460	15	920	50	600	
	E-AU-A2L-H151CS	590	710	505	15	560	50	600	
	E-AU2-A2L-H151CS	950	710	460	15	920	50	600	
	E-AU-A2L-H181CC	590	710	555	15	560	50	600	
	E-AU2-A2L-H181CC	950	710	460	15	920	50	600	
	E-AU-A2L-H181CS	590	710	555	15	560	50	600	
	E-AU2-A2L-H181CS	950	710	460	15	920	50	600	
	E-AU-A2L-H201CC	590	710	555	15	560	50	600	
	E-AU2-A2L-H201CC	950	710	460	15	920	50	600	
	E-AU-A2L-H201CS	590	710	555	15	560	50	600	
	E-AU2-A2L-H201CS	950	710	460	15	920	50	600	
	E-AU-A2L-H221CC	590	710	555	15	560	50	600	
	E-AU2-A2L-H221CC	950	710	460	15	920	50	600	
	E-AU-A2L-H221CS	590	710	555	15	560	50	600	
	E-AU2-A2L-H221CS	1200	710	560	15	1170	50	600	
	E-AU-A2L-H251CC	950	710	710	15	920	50	600	
	E-AU2-A2L-H251CC	1200	710	560	15	1170	50	600	
	E-AU-A2L-H251CS	590	710	555	15	560	50	600	
	E-AU2-A2L-H251CS	1200	710	560	15	1170	50	600	
	E-AU-A2L-H281CC	950	710	710	15	920	50	600	
	E-AU2-A2L-H281CC	1200	710	560	15	1170	50	600	
	E-AU-A2L-H281CS	950	710	710	15	920	50	600	
	E-AU2-A2L-H281CS	1200	710	560	15	1170	50	600	
	<b>H2</b>	E-AU-A2L-H290CS	950	710	710	15	920	50	600
		E-AU2-A2L-H290CS	1200	710	560	15	1170	50	600
E-AU-A2L-H300CC		950	710	860	15	920	50	600	
E-AU2-A2L-H300CC		1200	710	760	15	1170	50	600	
E-AU-A2L-H300CS		950	710	710	15	920	50	600	
E-AU2-A2L-H300CS		1200	710	560	15	1170	50	600	
E-AU-A2L-H350CC		950	710	860	15	920	50	600	
E-AU2-A2L-H351CC		1200	710	760	15	1170	50	600	

RANGE GAMMA	HOUSING UNITS OVERALL DIMENSIONS DIMENSIONE GRUPPI CARENATI								
	MODEL MODELLO	L	P	H	A	B	C	D	
		[mm]	[mm]	[mm]	[mm]	[mm]	[mm]	[mm]	
<b>H2</b>	E-AU-A2L-H380CC	950	710	860	15	920	50	600	
	E-AU2-A2L-H381CC	1200	710	760	15	1170	50	600	
	E-AU-A2L-H390CS	950	710	710	15	920	50	600	
	E-AU2-A2L-H390CS	1200	710	560	15	1170	50	600	
	<b>H33</b>	E-AU-A2L-H355CS	950	860	710	15	926	50	650
E-AU2-A2L-H355CS		1200	860	710	15	1170	50	650	
E-AU-A2L-H405CC		950	860	860	15	920	50	650	
E-AU2-A2L-H405CC		1200	860	760	15	1170	50	650	
E-AU-A2L-H405CS		950	860	710	15	920	50	650	
E-AU2-A2L-H405CS		1200	860	710	15	1170	50	650	
E-AU-A2L-H505CC		950	860	860	15	920	50	650	
E-AU2-A2L-H505CC		1200	860	760	15	1170	50	650	
E-AU-A2L-H505CS		950	860	860	15	920	50	650	
E-AU2-A2L-H505CS		1200	860	760	15	1170	50	650	
E-AU-A2L-H705CC		950	860	860	15	920	50	650	
E-AU2-A2L-H705CC		1200	860	760	15	1170	50	650	
E-AU-A2L-H755CC		1660	860	860	15	1630	50	650	
<b>H35</b>		E-AU2-A2L-H751CS	1200	860	760	15	1170	50	650
		E-AU2-A2L-H1002CC	1660	860	860	15	1630	50	650
	E-AU2-A2L-H801CS	1660	860	860	15	1630	50	650	
	E-AU2-A2L-H1003CC	1660	860	860	15	1630	50	650	
	E-AU2-A2L-H901CS	1660	860	860	15	1630	50	650	
<b>H41</b>	E-AU2-A2L-H1501CC	1660	860	1015	15	1630	50	650	
	E-AU2-A2L-H1501CS	1660	860	860	15	1630	50	650	
	E-AU2-A2L-H2001CC	1660	860	1015	15	1630	50	650	
	E-AU2-A2L-H1601CS	1660	860	1015	15	1630	50	650	
	E-AU4-A2L-H2201CC	1660	860	1515	15	1630	50	650	
	E-AU2-A2L-H2201CS	1660	860	1515	15	1630	50	650	
<b>H5</b>	E-AU4-A2L-H2401CC	1660	860	1515	15	1630	50	650	
	E-AU4-A2L-H2500CS	1660	860	1535	15	1630	50	650	
	E-AU4-A2L-H3000CC	1660	860	1535	15	1630	50	650	
	E-AU4-A2L-H2700CS	1660	860	1535	15	1630	50	650	
	E-AU4-A2L-H3200CC	1660	860	1535	15	1630	50	650	
E-AU4-A2L-H2900CS	1660	860	1535	15	1630	50	650		

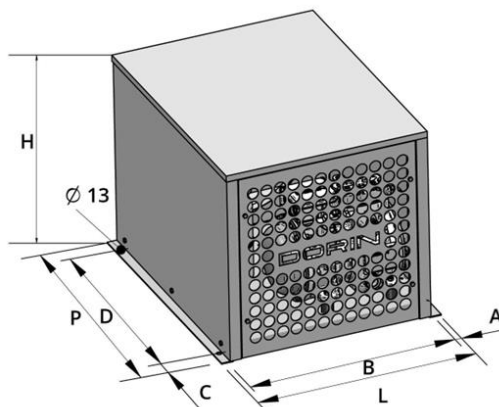



### **DORIN WEB SOFTWARE**

**Open the camera app on your device and point it at the QR code to scan it. Make sure that all the four corners of the QR code are in view. A pop-up notification will appear on your screen, tap the notifications to launch the code.**

Aprire l'app della Fotocamera sul proprio dispositivo ed inquadrare il codice QR per scannerizzarlo. Tutti i quattro angoli del codice devono essere visibili. Una notifica pop-up apparirà sullo schermo, cliccare sulla notifica per eseguire il comando



OFFICINE MARIO DORIN S.p.A.  
Via Aretina 388, 50061 Compiobbi - Florence, Italy Tel.  
+39 055 62321 1 - Fax +39 055 62321 380

[dorin@dorin.com](mailto:dorin@dorin.com)  
[www.dorin.com](http://www.dorin.com)